

---

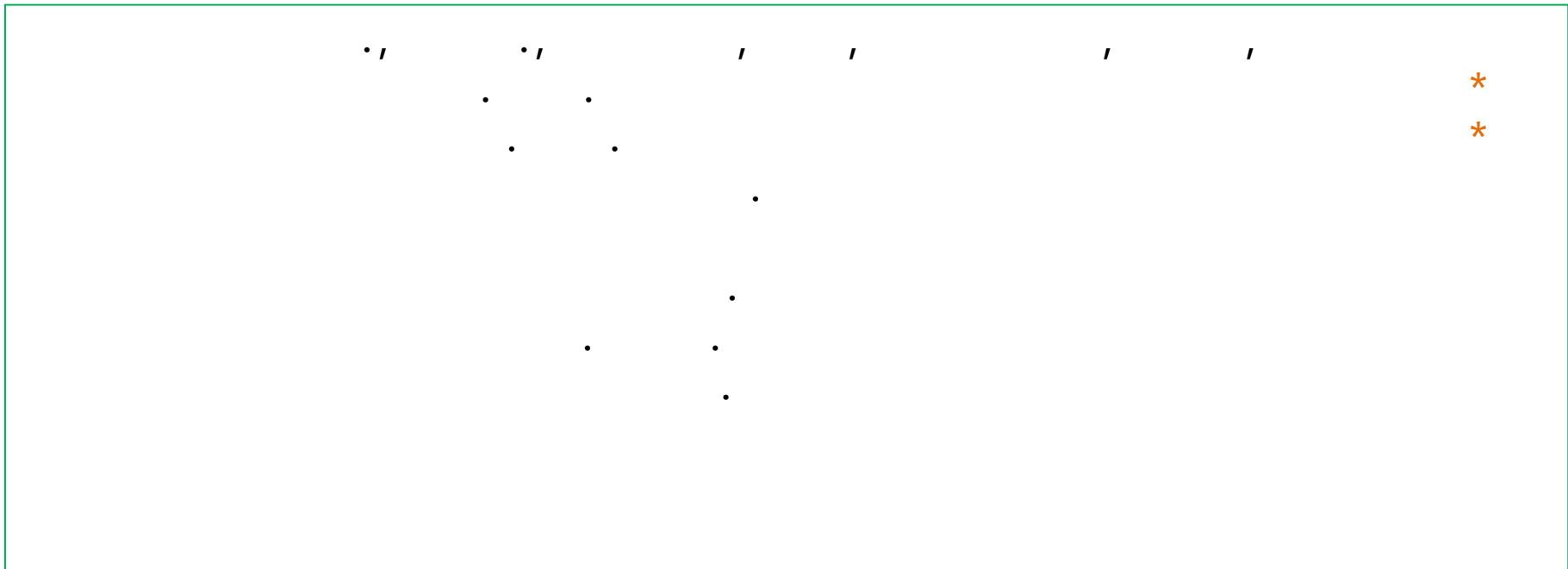

A large empty rectangular box with a purple border, containing a vertical column of 12 green diamond shapes on the left side.





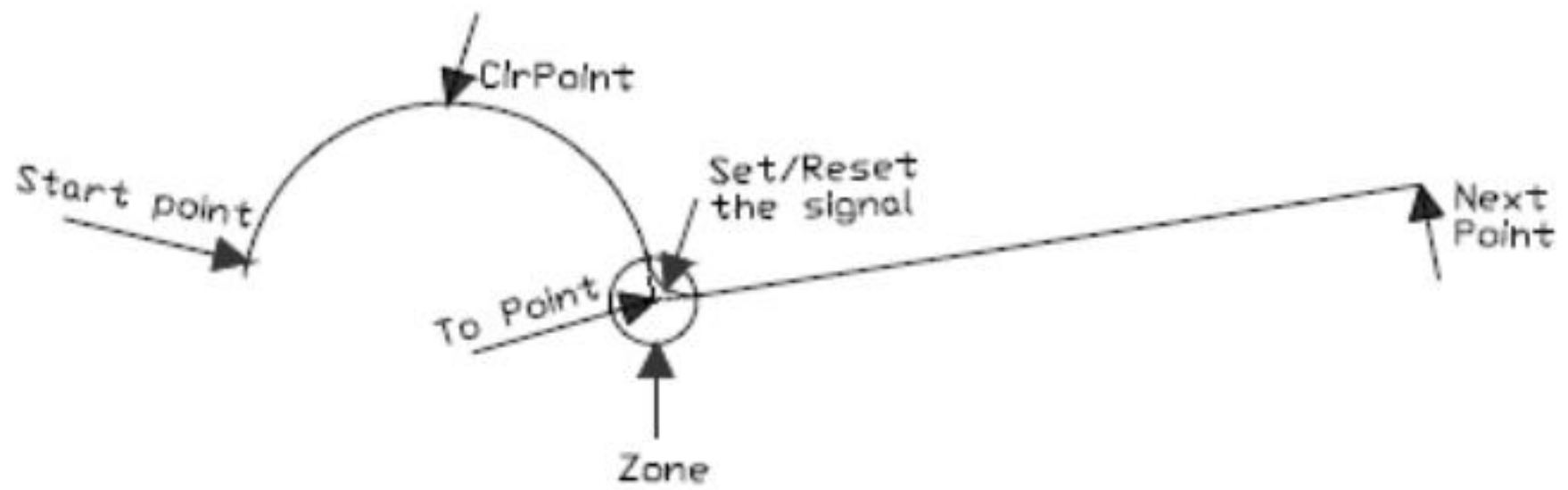
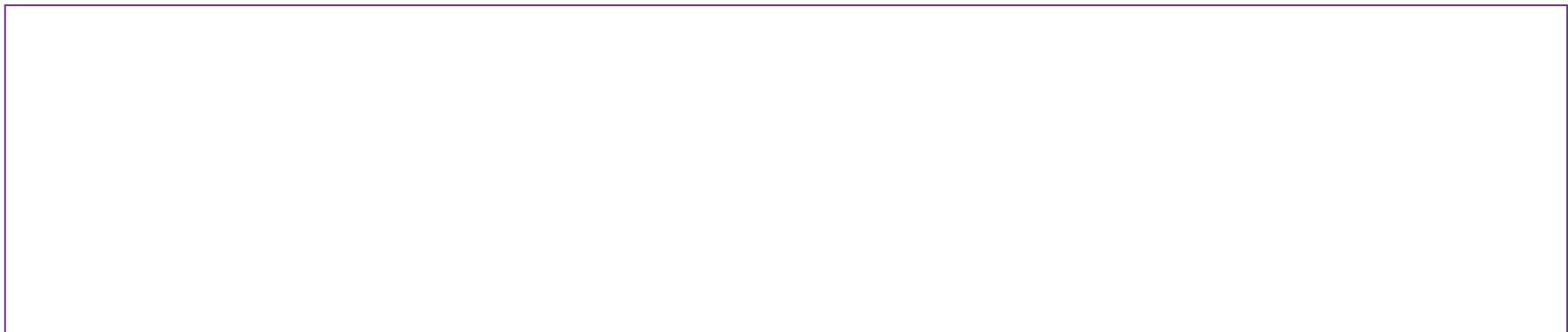

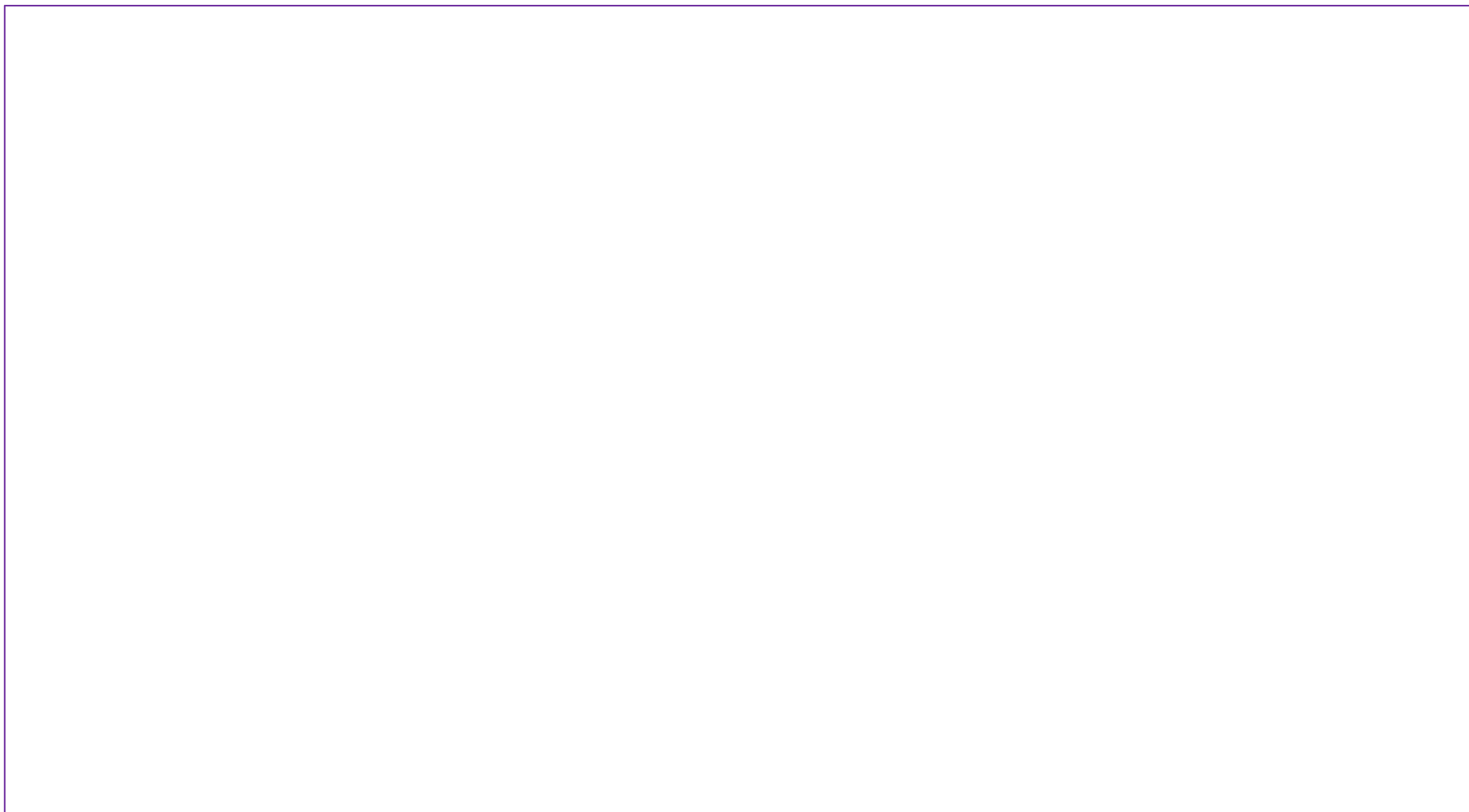

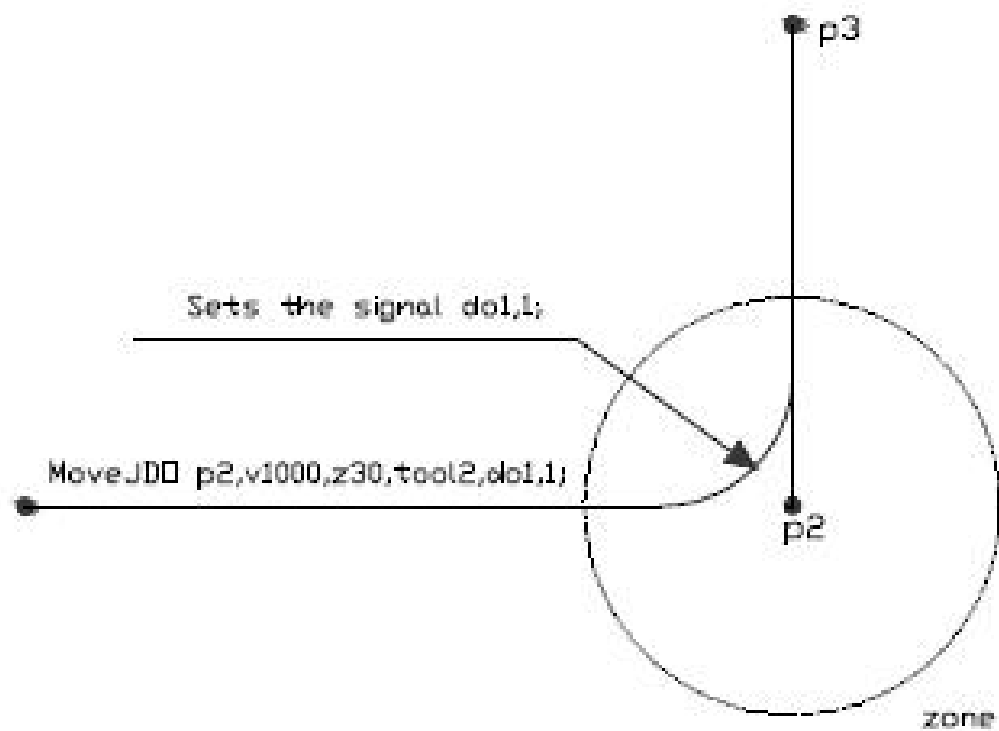
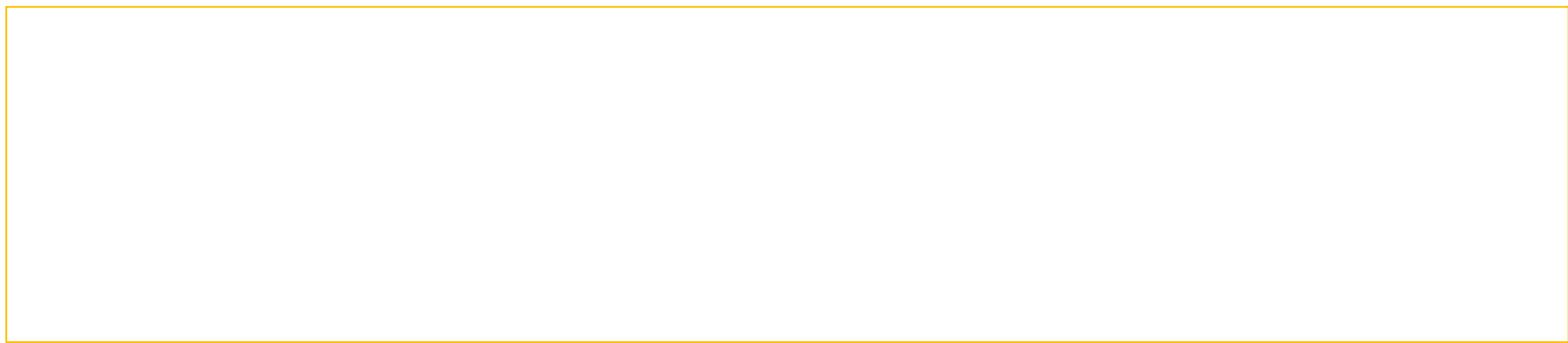

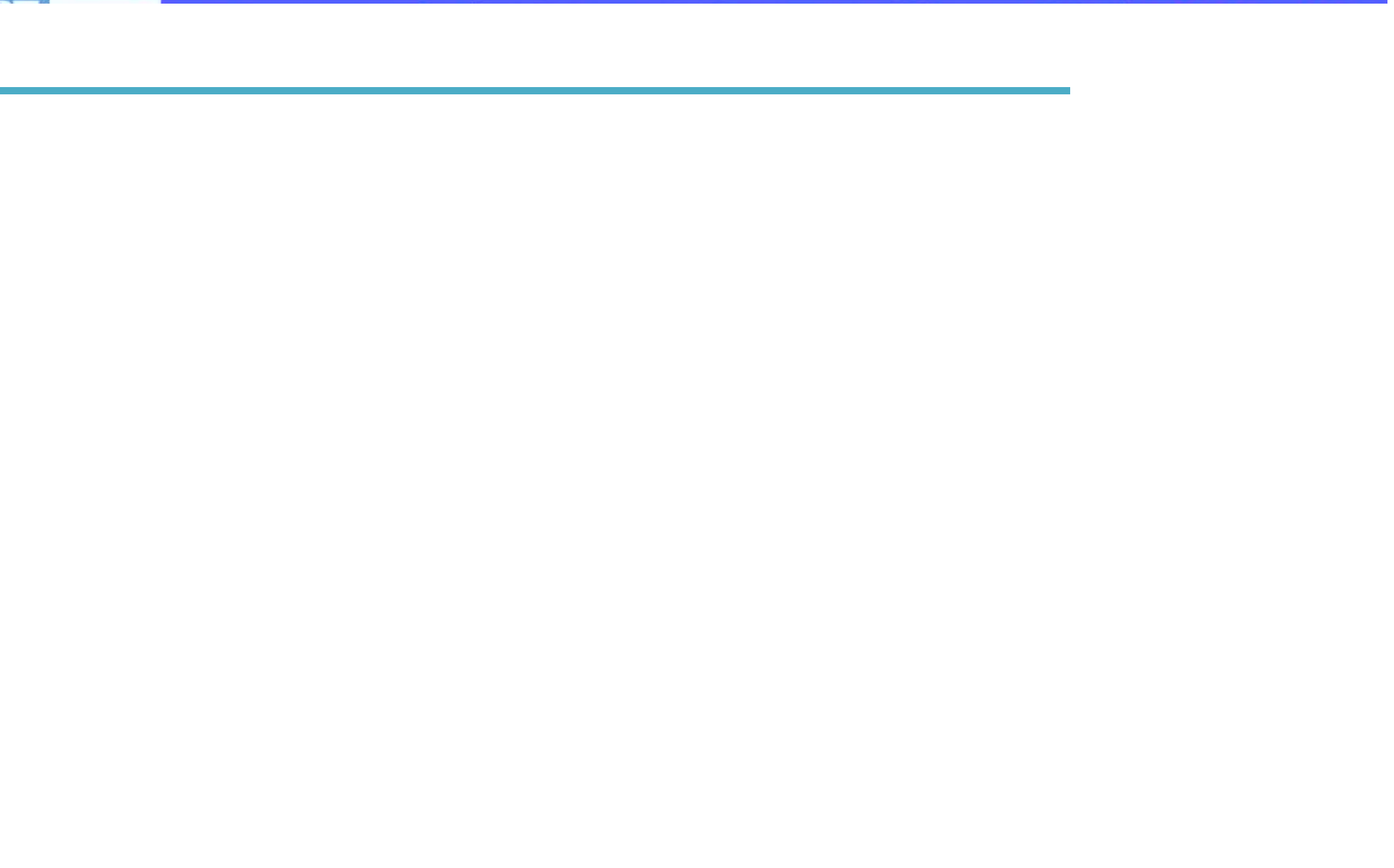

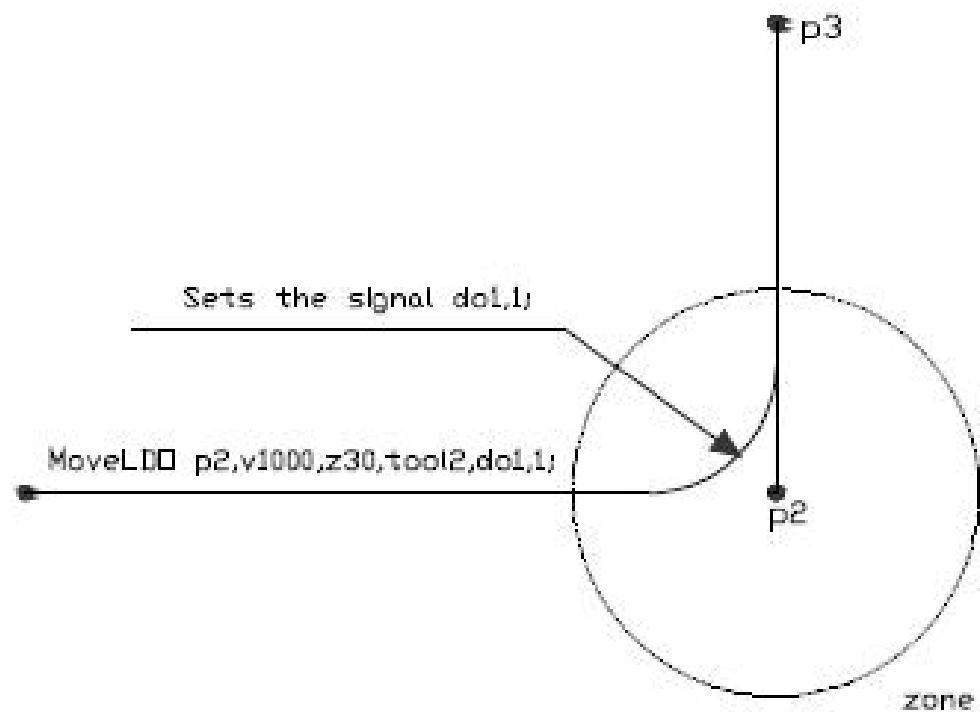



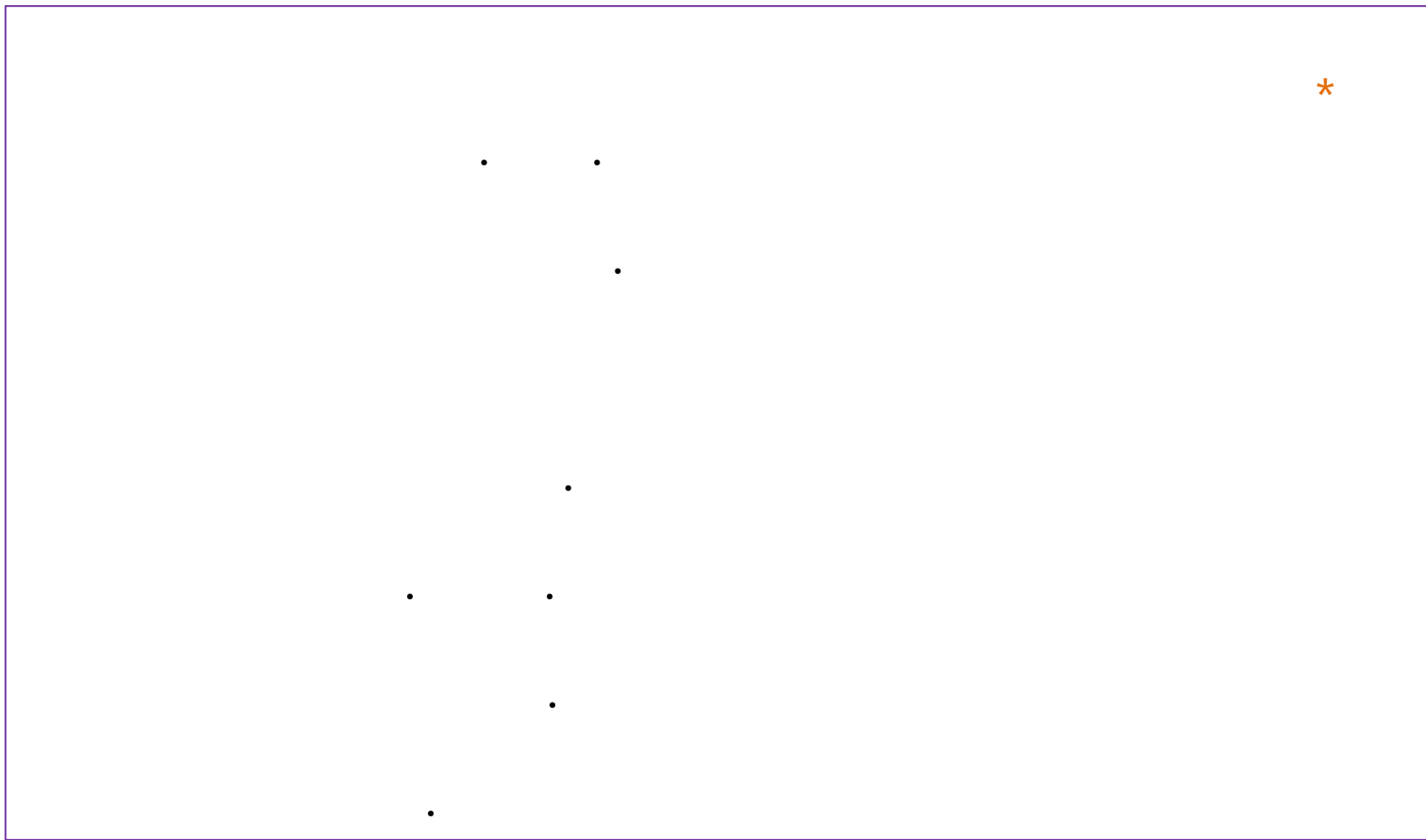

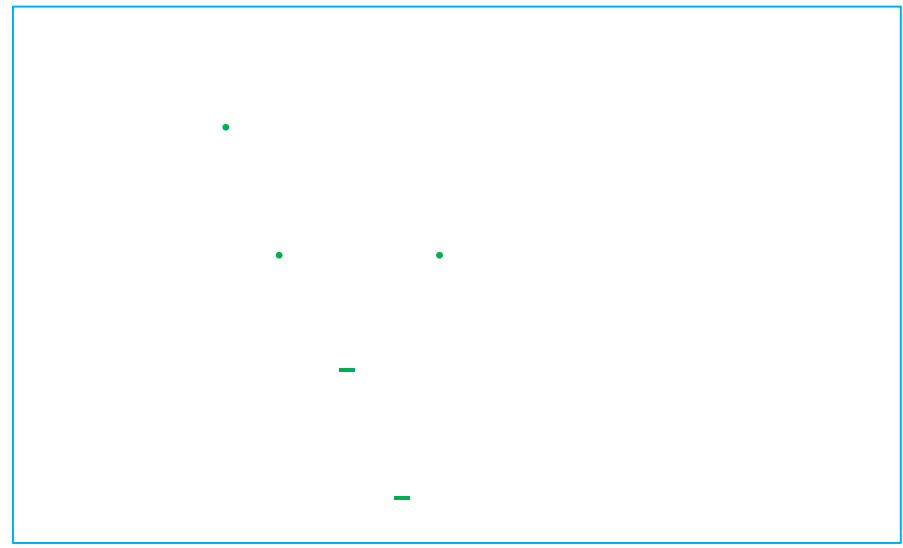
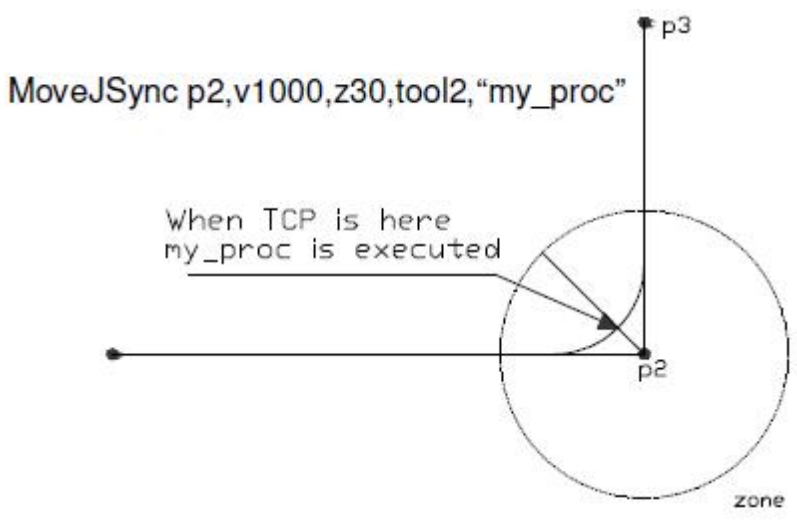
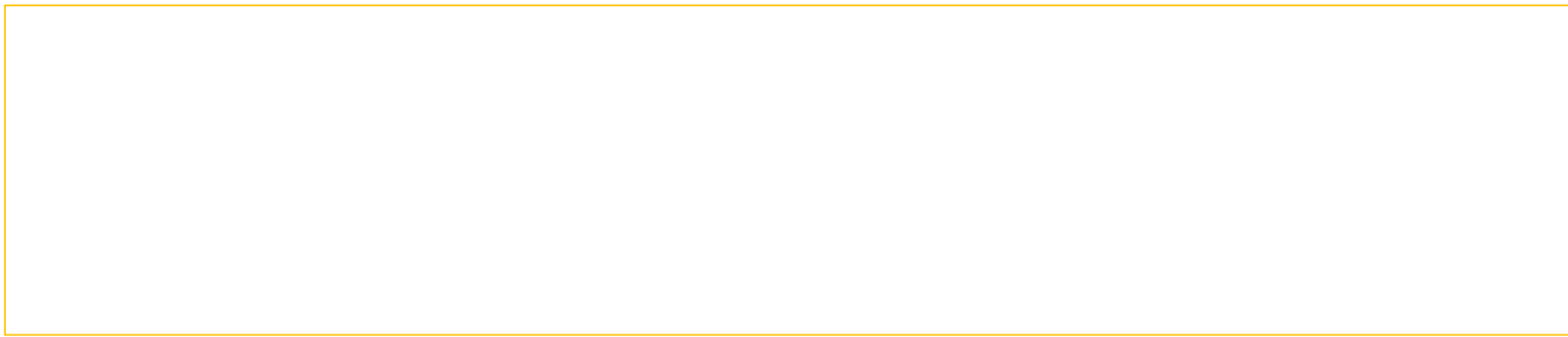

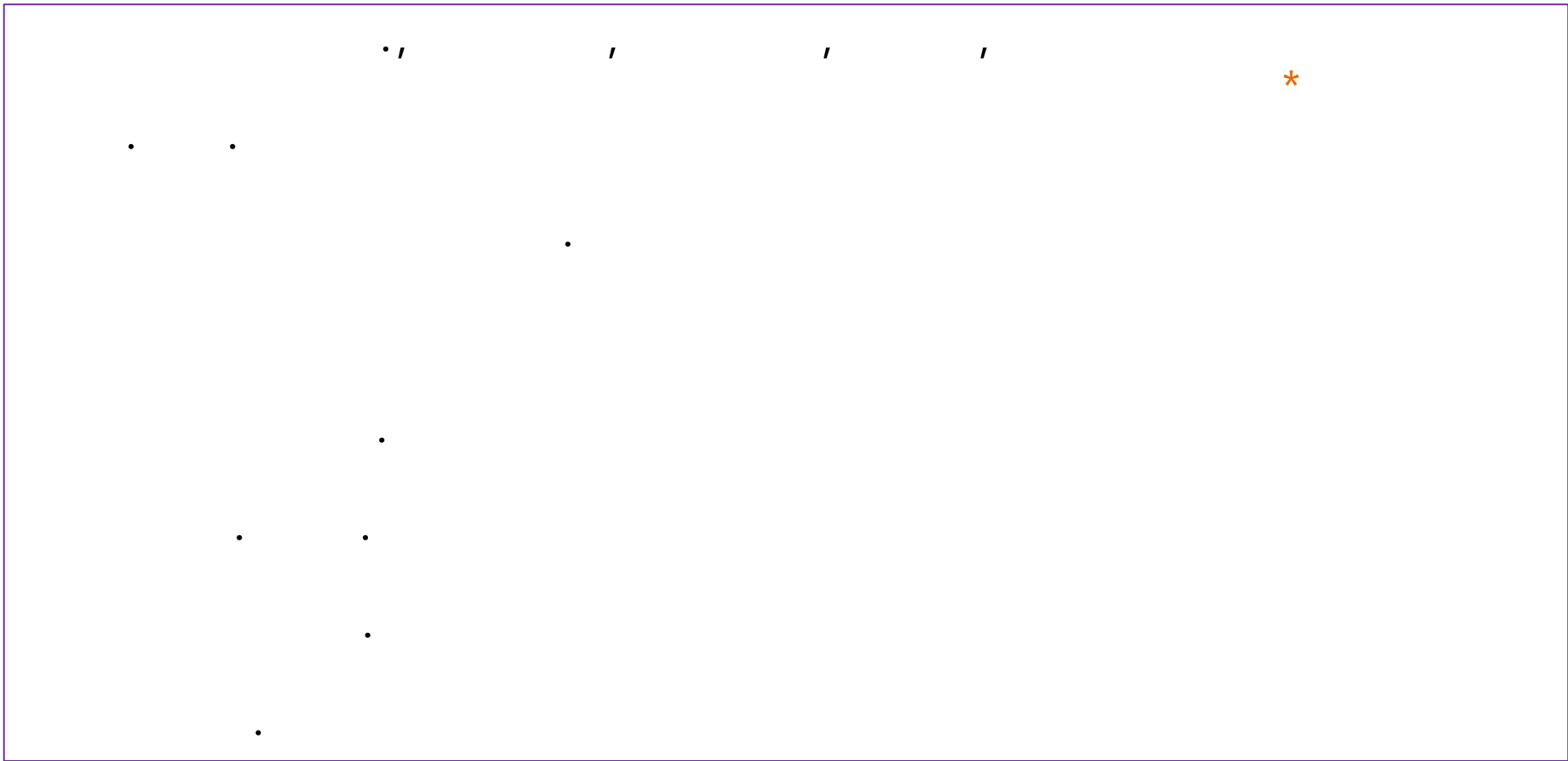

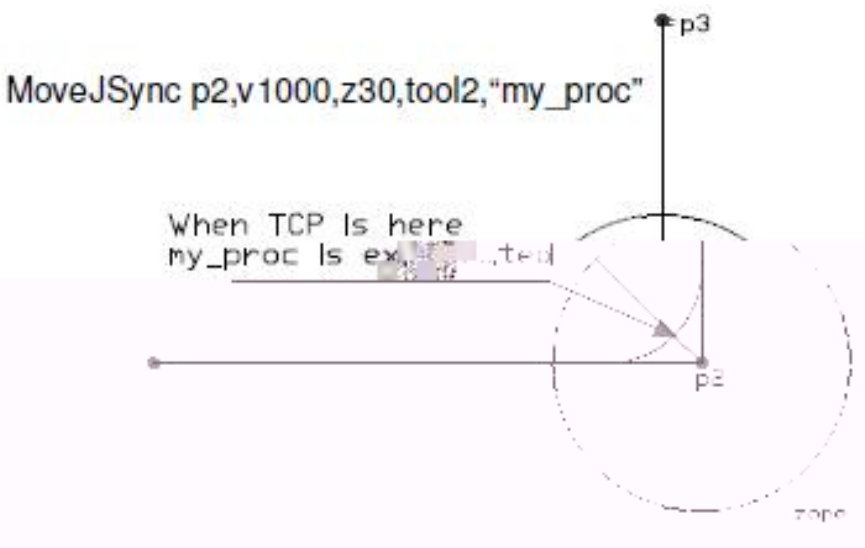

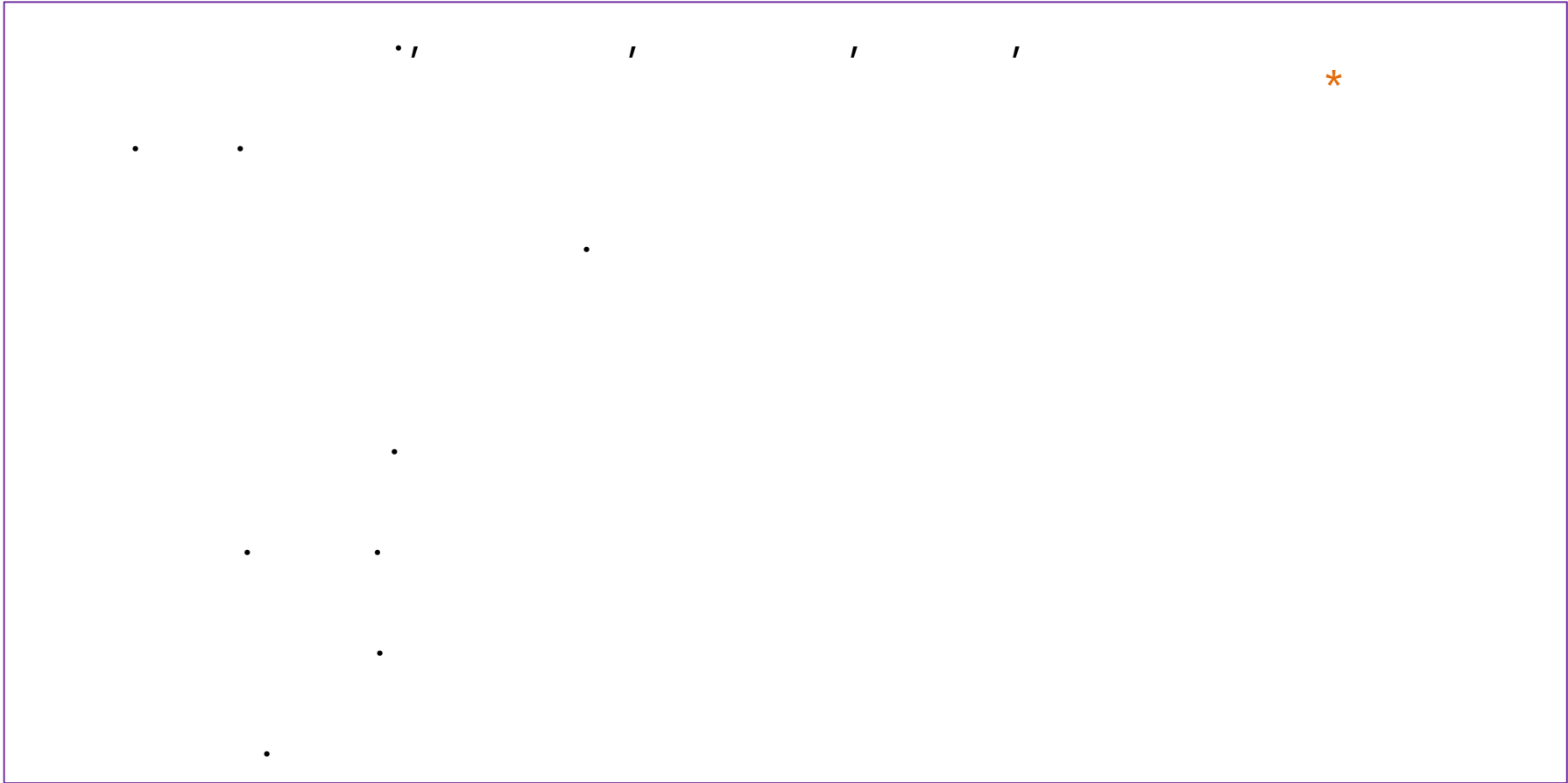

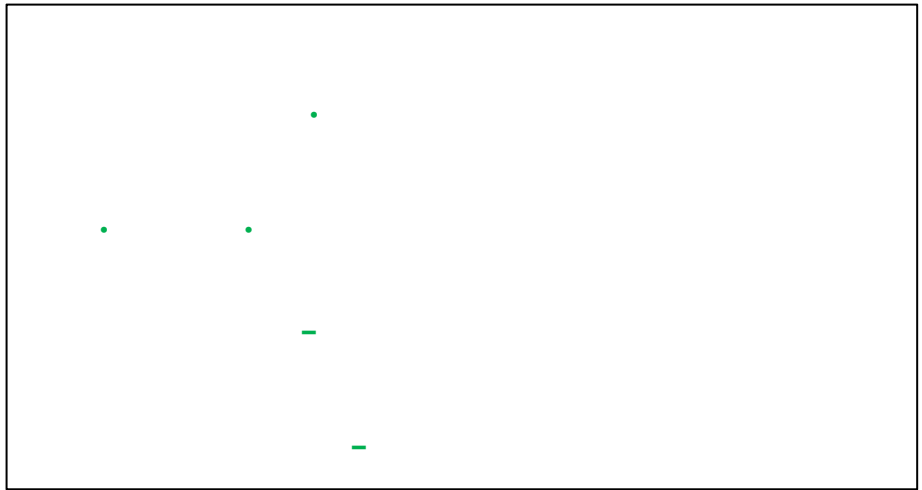
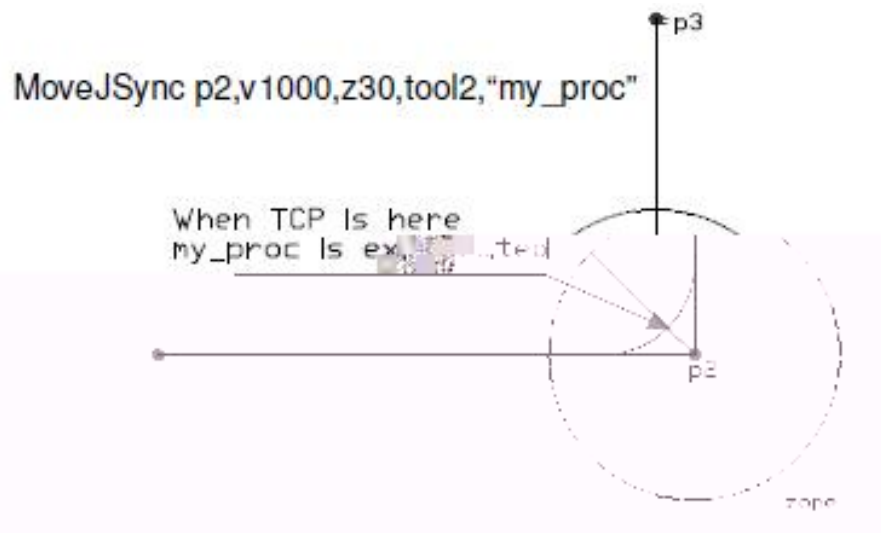





---

	/
	- -





• / • •

/ •

• •

•

•

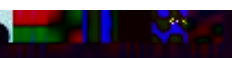



```
VAR triggdata gunon;  
TriggIO gunon,10\ Dop:=gun,1;  
TriggL pl,v500,gunon,z50,gun1;
```

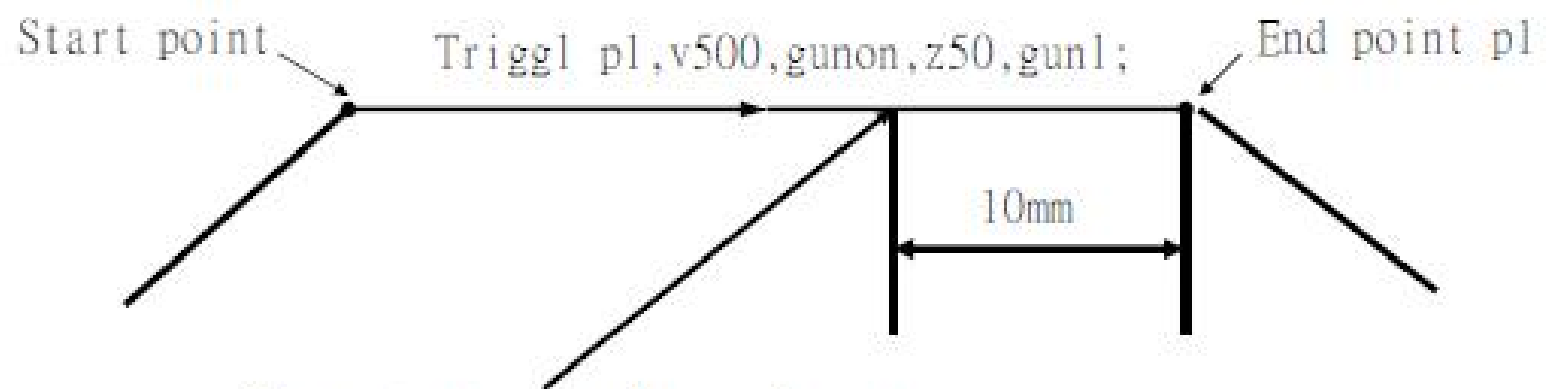

The output signal gun is set when the TCP is here



-

.

-

/



•

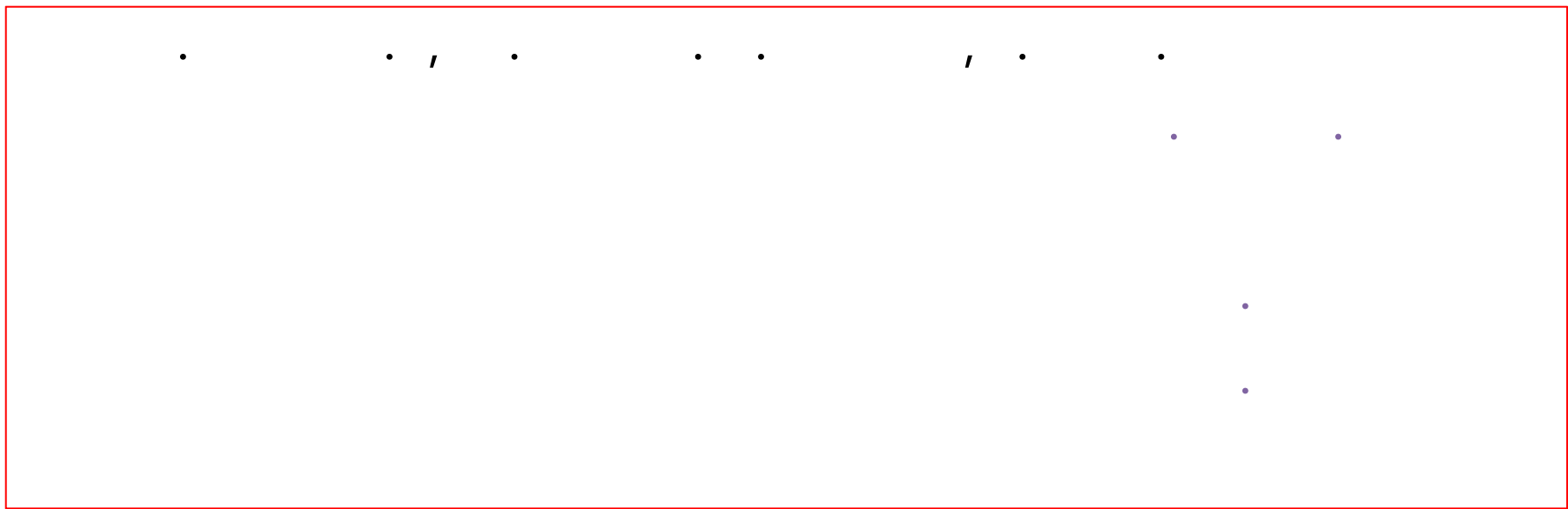



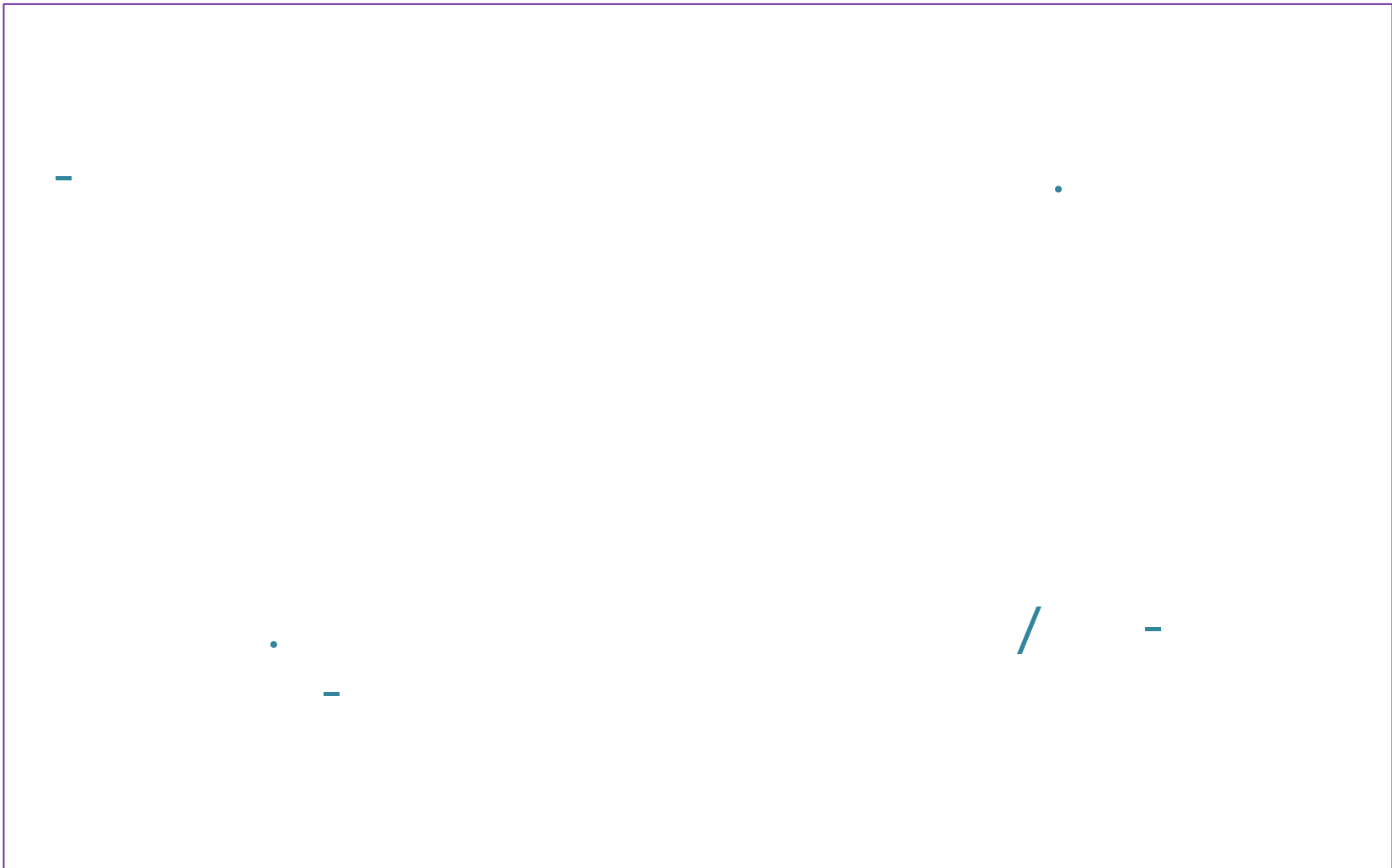

```
VAR intnum intno1;  
VAR triggdata triggl;  
CONNECT intno1 WITH trap1;  
Triggint triggl,5,intno1;  
TriggL p1,v500,triggl,z50,gun1;  
TriggL p2,v500,triggl,z50,gun1;  
Idelete intno1;
```

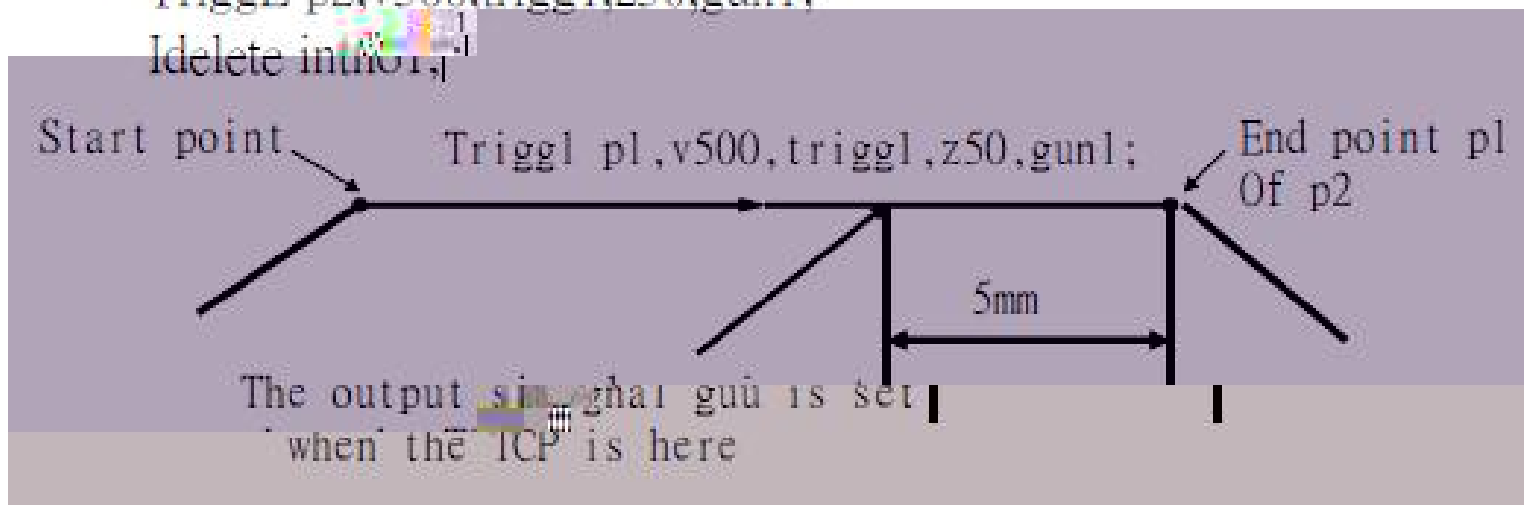





• / • • • / •

- 
- 
- 
- 

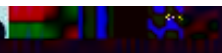



VAR triggdata gunon;

TriggEquip gunon,10,0.1\ Dop:=gun,1;

TriggL p1,v500,gunon,z50,gun1;

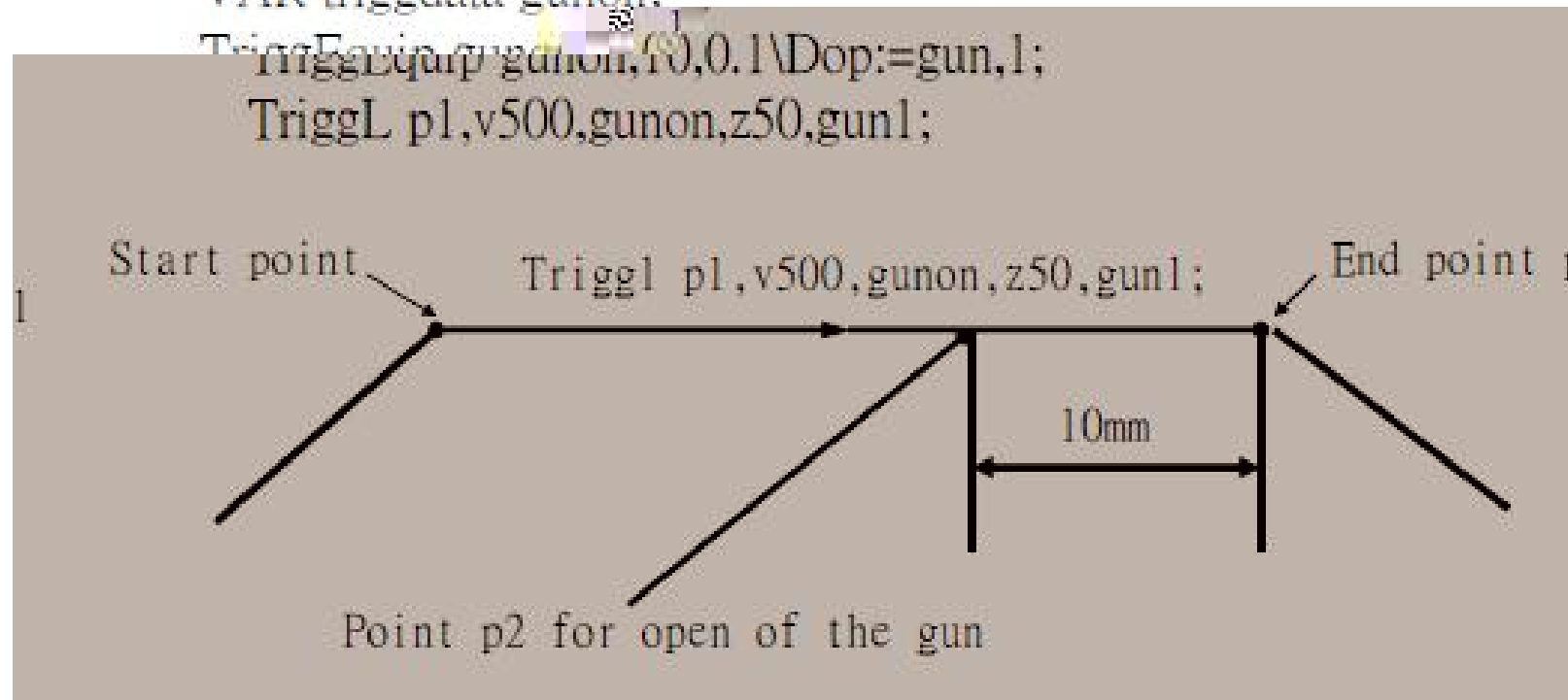

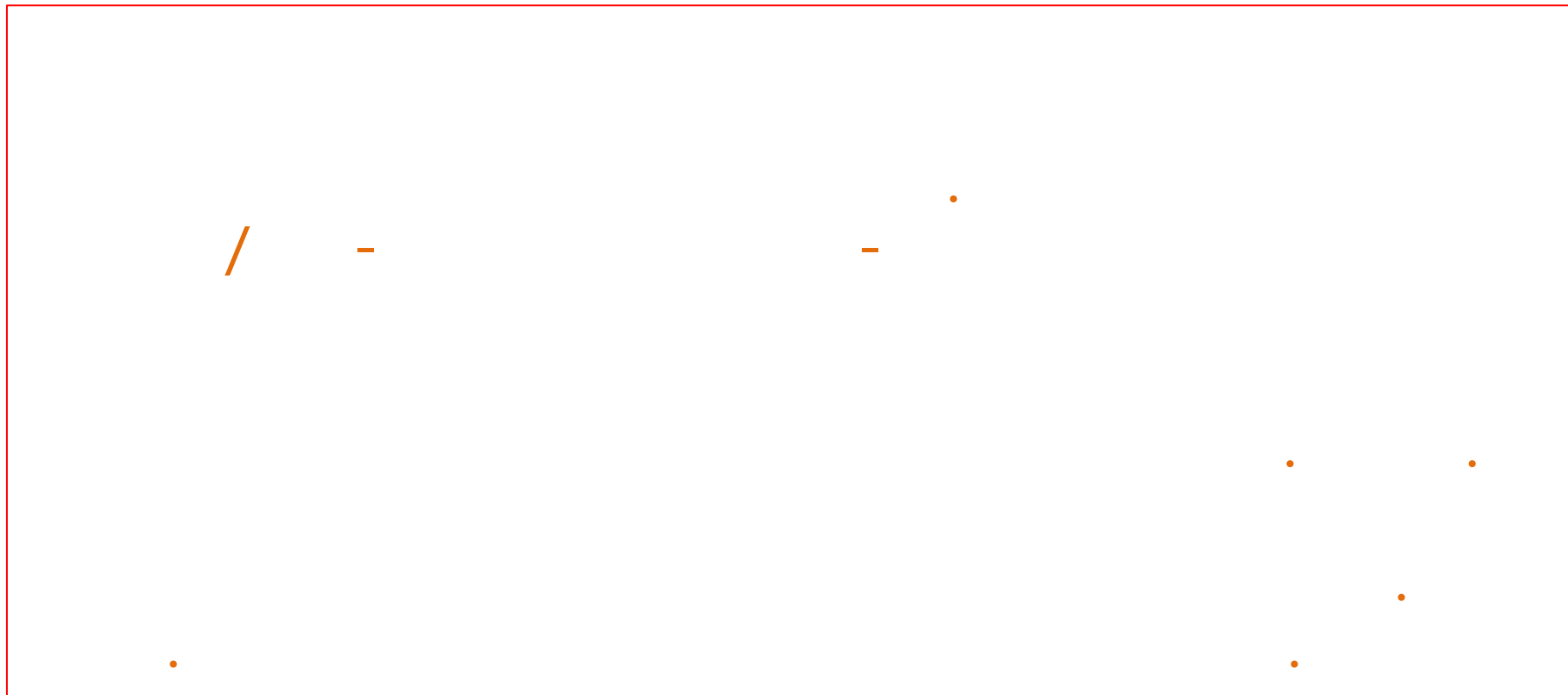

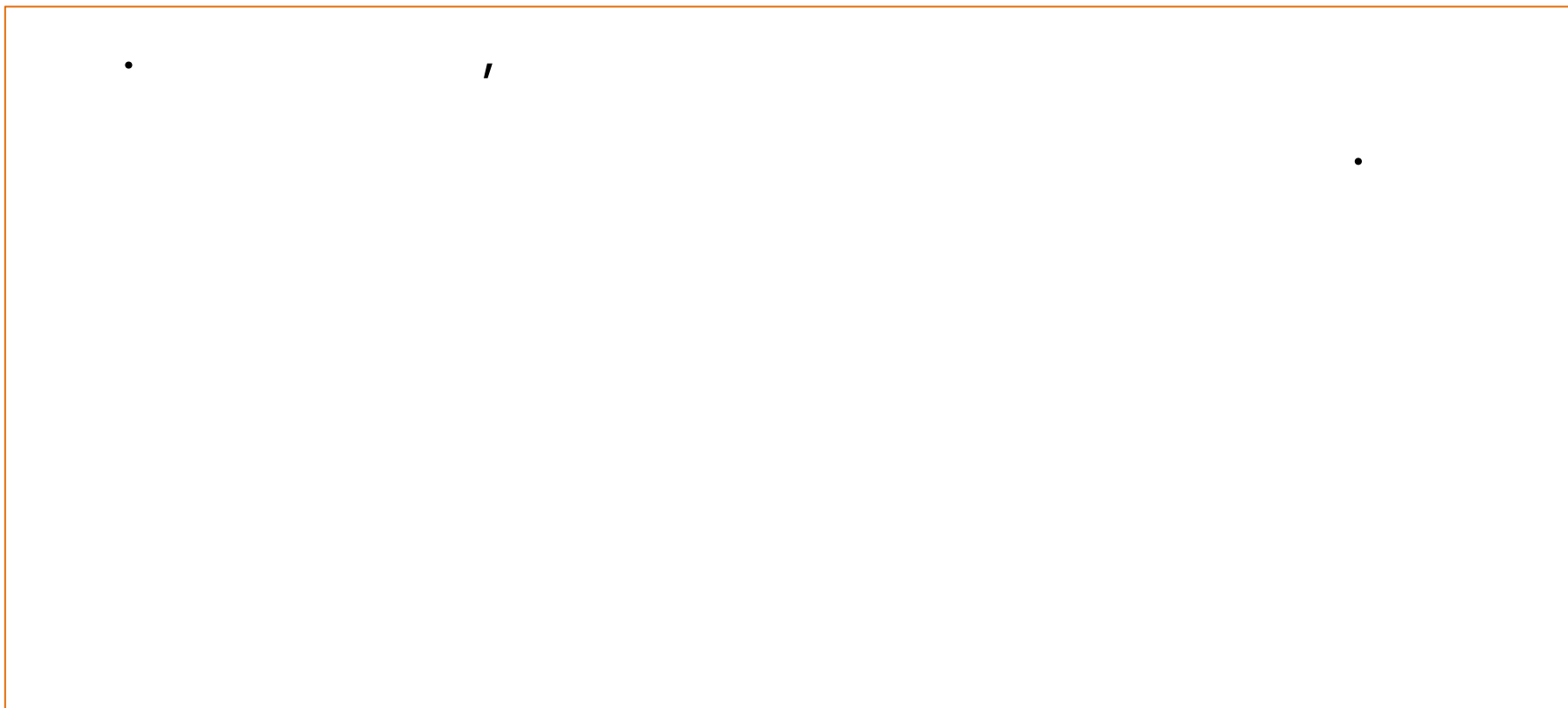



.	
. .	
. . - .	
. . - .	
. .	
- . .	
. .	
.	
	. .
	. .
.	. .



-

• •	
• •	
•	
• •	
•	
• •	/





- 
- 

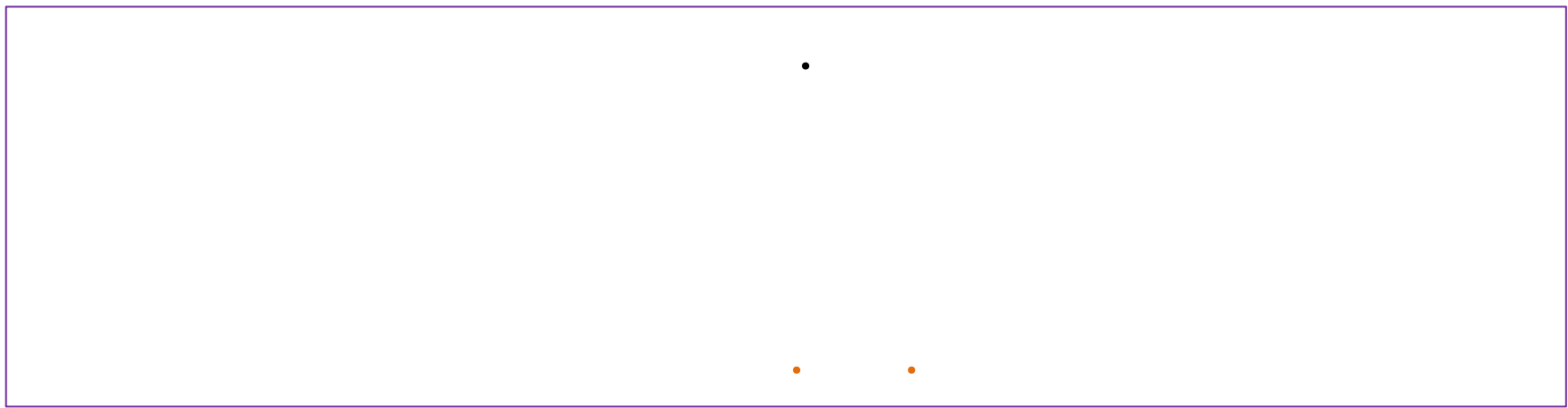

- 

- 
-

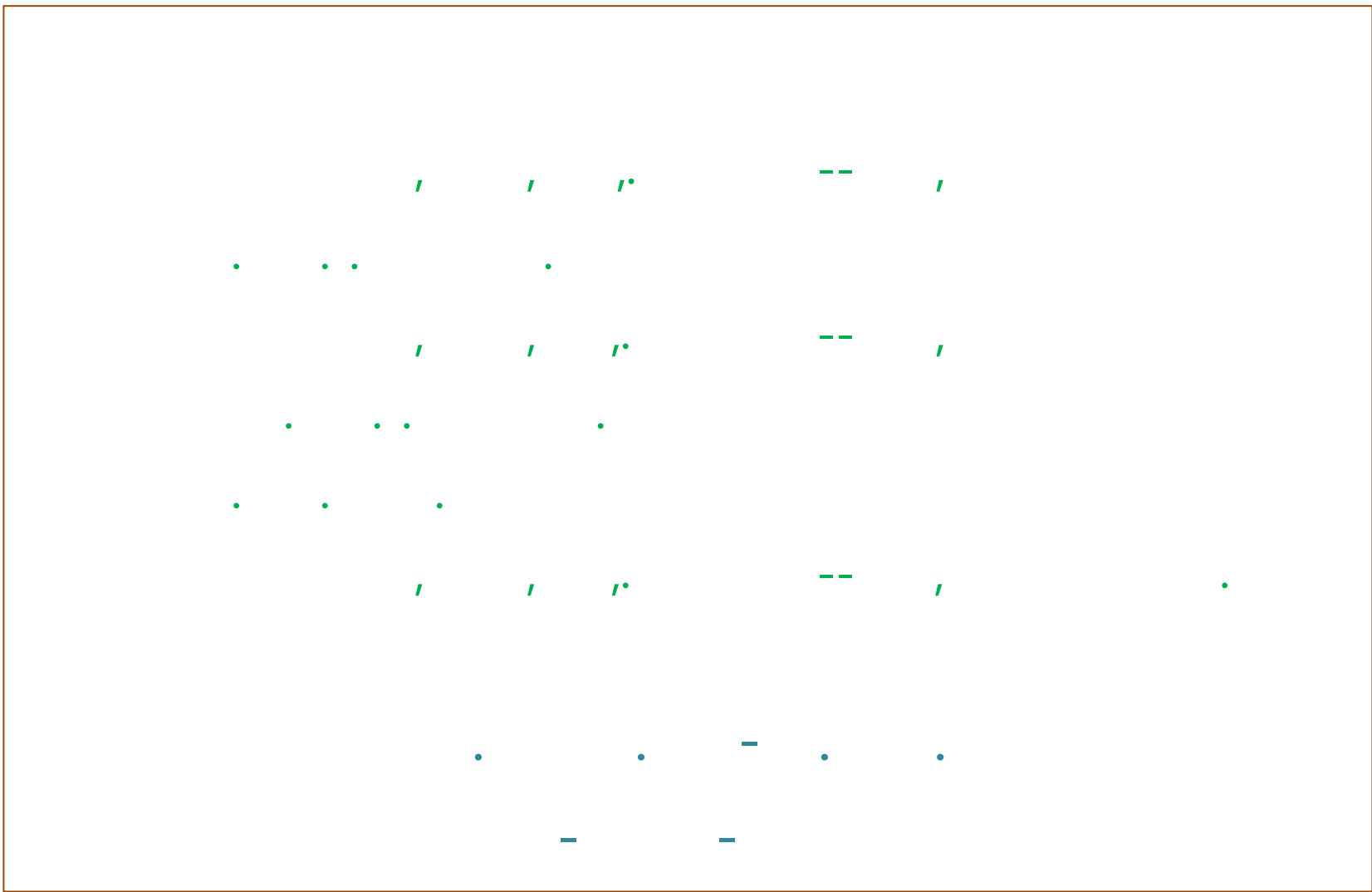



- 
- 



- 
- 
- 
- 
-

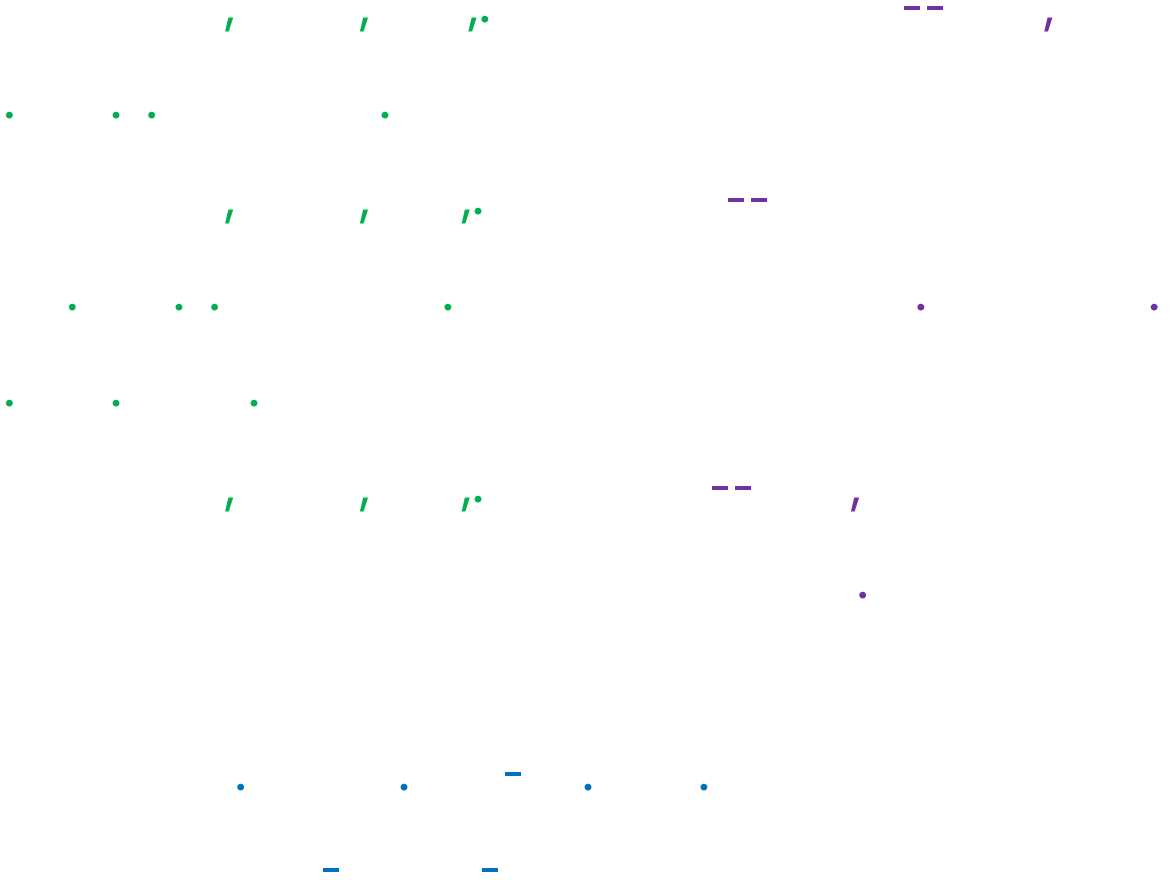



---

-	
- .	



---

.	
-	



Blue rectangular area.



---

.	





---

.	
	/



---

.	/

-	
-	.. . . .
-	.. .
.	
- .	
.	. . .. .
.	
- . .	